

6FM100 12V 100Ah(20hr)

The rechargeable batteries are lead-lead dioxide systems. The dilute sulfuric acid electrolyte is absorbed by separators and plates and thus immobilized. Should the battery be accidentally overcharged producing hydrogen and oxygen, special one-way valves allow the gases to escape thus avoiding excessive pressure build-up. Otherwise, the battery is completely sealed and is, therefore, maintenance-free, leak proof and usable in any position.



Battery Construction

Component	Positive plate	Negative plate	Container	Cover	Safety valve	Terminal	Separator	Electrolyte
Raw material	Lead dioxide	Lead	ABS	ABS	Rubber	Copper	Fiberglass	Sulfuric acid

General Features

- Absorbent Glass Mat (AGM) technology for efficient gas recombination of up to 99% and freedom from electrolyte maintenance or water adding.
- Not restricted for air transport-complies with IATA/ICAO Special Provision A67.
- UL-recognized component.
- Can be mounted in any orientation.
- Computer designed lead, calcium tin alloy grid for high power density.
- Long service life, float or cyclic applications.
- Maintenance-free operation.
- Low self discharge.

Dimensions and Weight

Length(mm / inch).....330 / 12.99
 Width(mm / inch).....171 / 6.73
 Height(mm / inch).....214 / 8.43
 Total Height(mm / inch).....220 / 8.66
 Approx. Weight(Kg / lbs).....32 / 70.5

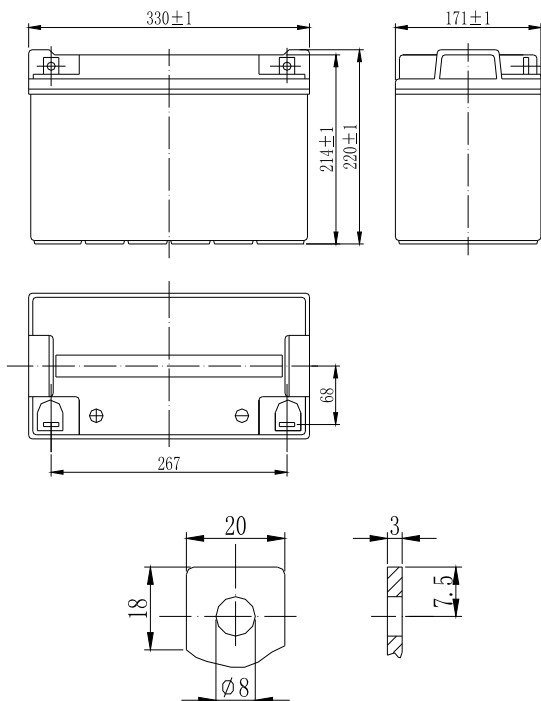

Performance Characteristics

Nominal Voltage12V
 Number of cell6
 Design Life10 years
 Nominal Capacity 77°F(25°C)
 20 hour rate (5A, 10.5V).....100Ah
 10 hour rate (9.6A, 10.5V).....96Ah
 5 hour rate (17A, 10.5V).....85Ah
 1 hour rate (63.5A, 9.6V).....63.5Ah
 Internal Resistance
 Fully Charged battery 77°F(25°C).....5mOhms
 Self-Discharge
 3% of capacity declined per month at 20°C(average)
 Operating Temperature Range
 Discharge-20~60°C
 Charge-10~60°C
 Storage-20~60°C
 Max. Discharge Current 77°F(25°C)900A(5s)
 Short Circuit Current2100A
 Charge Methods: Constant Voltage Charge 77°F(25°C)
 Cycle use14.4-14.7V
 Maximum charging current30A
 Temperature compensation-30mV/°C
 Standby use13.6-13.8V
 Temperature compensation-20mV/°C

Discharge Constant Current (Amperes at 77°F25°C)

End Point Volts/Cell	5min	10min	15min	30min	1h	3h	5h	10h	20h
1.60V	323	221	182	103	63.5	25.7	18.0	9.90	5.15
1.65V	296	207	173	99	62.5	25.2	17.7	9.85	5.10
1.70V	270	192	164	96	61.5	24.7	17.4	9.80	5.04
1.75V	242	179	153	93	60.5	24.1	17.0	9.60	5.00
1.80V	214	164	143	91	59.5	23.4	16.7	9.30	4.80

Discharge Constant Power (Watts at 77°F25°C)

End Point Volts/Cell	5min	10min	15min	30min	45min	1h	2h	3h	5h
1.60V	556	392	320	194	144	124	70.3	49.6	34.7
1.65V	517	372	315	188	140	122	69.1	49.0	34.5
1.70V	478	353	305	183	137	121	67.8	48.5	34.2
1.75V	441	334	294	177	134	117	66.6	47.9	34.0
1.80V	401	312	284	171	131	114	65.9	47.1	33.7

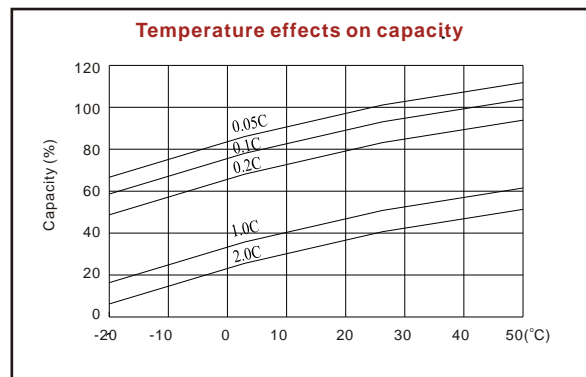
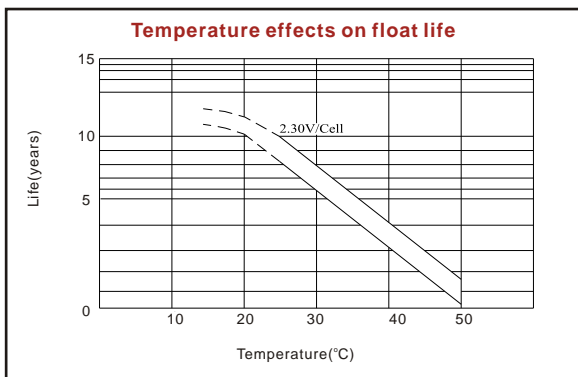
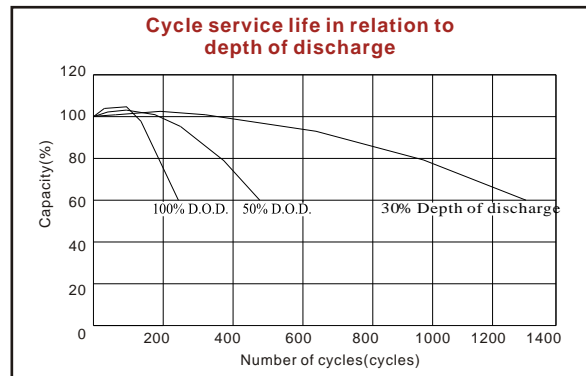
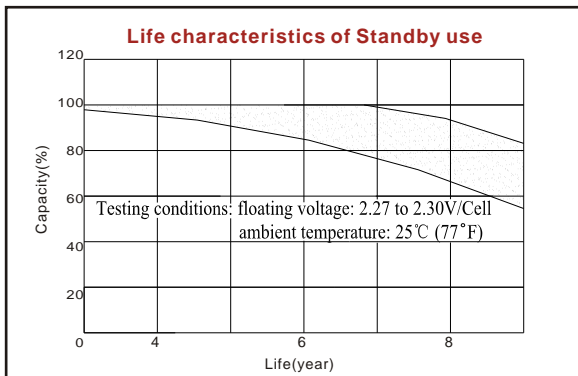
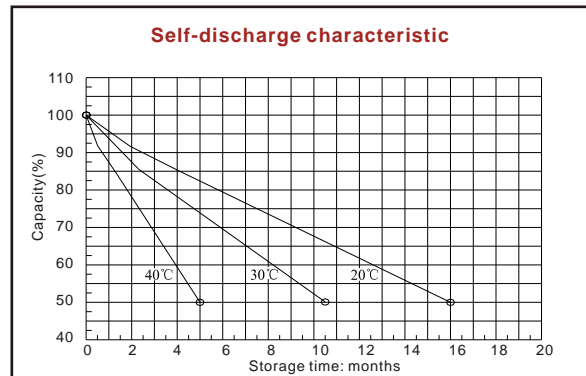
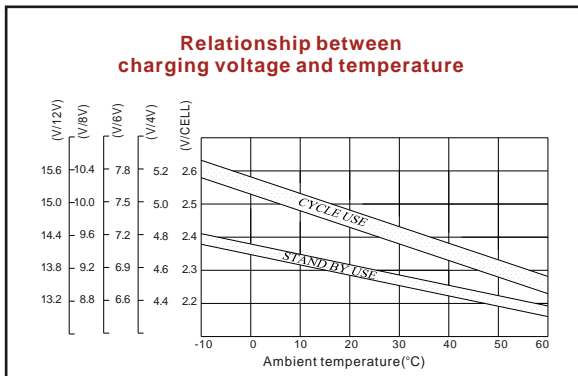
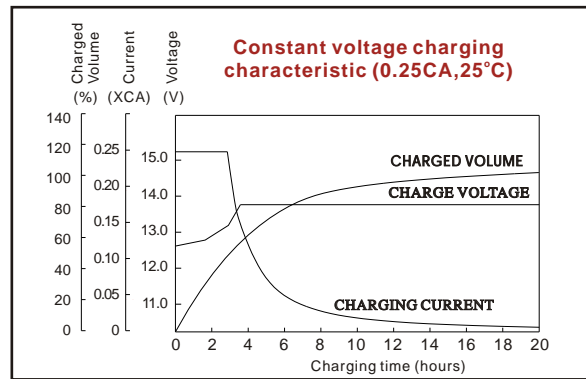
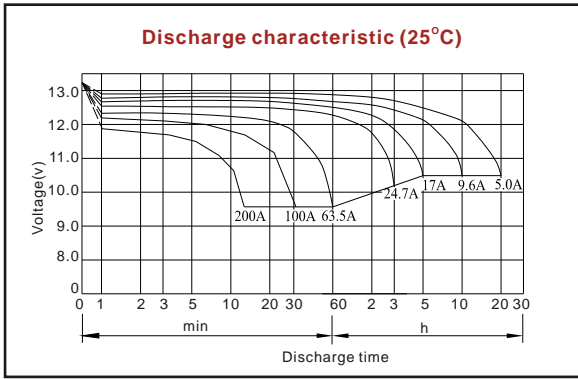

ISO9001:2000

MH25860

G4M19906-9202-E-16

Shenzhen Center Power Tech. Co., Ltd.
 Center Power Industrial Park, Tongfu Industrial District Dapeng Town, 518120 Shenzhen, China
 Tel: (+86-755) 8431 8088 Fax: (+86-755) 8431 8038 E-mail: sales@vision-batt.com

www.vision-batt.com